

800SJ250-43

Product Description: 8" Super Joist 18GA (2-1/2" Flange, 43mil)

Coating: G60 (standard), G90 (special order)

Specification Section: 05.40.00 (Cold-Formed Metal Framing)



GEOMETRIC PROPERTIES			
Web Depth	8 in.	Yield Strength, Fy	33 ksi
Flange Width	2.50 in.	Design Thickness	0.0451 in.
Lip Length	0.625 in.	Min. Steel Thickness	0.0428 in.

GROSS PROPERTIES		
Area (in ²)	Total cross-sectional steel area	0.6273
Weight (lb/ft)	Linear weight per foot	2.1328
I _x (in ⁴)	Moment of inertia about the x-axis	6.0156
S _x (in ³)	Section modulus about the x-axis	1.5039
R _x (in)	Radius of gyration about the x-axis	3.0968
I _y (in ⁴)	Moment of inertia about the y-axis	0.5000
R _y (in)	Radius of gyration about the y-axis	0.8928

EFFECTIVE PROPERTIES		
Max (in-k)	Maximum allowable bending moment	18.3198
I _{xe} (in ⁴)	Effective moment of inertia (x-axis)	5.0137
S _{xe} (in ³)	Effective section modulus (x-axis)	1.1103
V _{av} (k)	Maximum allowable shear force about the y-axis	607.1

TORSIONAL PROPERTIES		
J x 1000 (in ⁴)	St. Venant torsional constant	0.425
C _w (in ⁶)	Warping constant	6.188
X _o (in)	Distance from shear center to centroid	1.671
R _o (in)	Polar radius of gyration	3.630
Beta	Torsional Flexural Constant	0.788

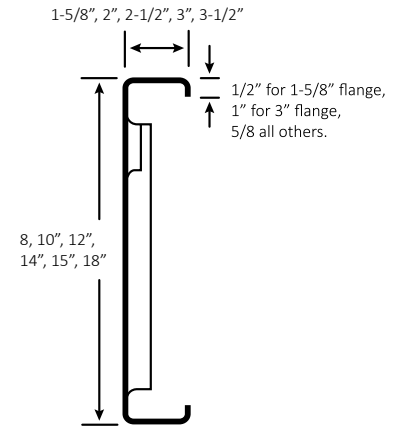

TYPICAL JOIST MEMBER SIZING				
A	B	C	D	E
Section Web Depth (in)	Large Hole Diameter (in)	Large Hole Spacing (in o.c.)	Small Hole Diameter (in)	Minimum Distance from End to Center of First Large Hole (in)
8	4.25	9	1	22

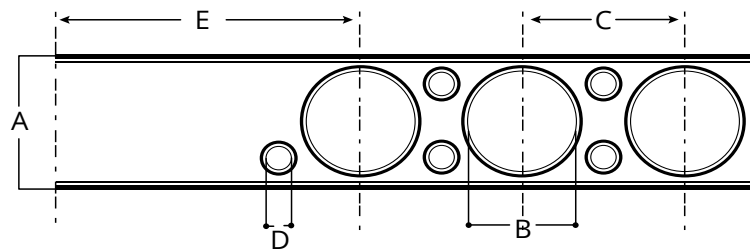

CODES AND STANDARDS:

Super Stud/EB Metal US products comply with the applicable provisions of the following:

- International Building Code (IBC): 2006–2024
- AISI S100-16 (2020) w/S2-20
- Sheet Steel: ASTM A1003/A1003M; ASTM A653/A653M
- Galvanized Coating: ASTM A653/A653M

Structural Members:

- ASTM C955; AISI S240
- Installed per ASTM C1007

Additional Standards:

- AISI S201; AISI S202

3rd Party Certification

For LEED Letter requests please submit through:
www.buysuperstud.com or www.ebmetal.us